

SPECIFICATIONS	Model	LH-series							
	LH430	30kW, 3-phase							
<p>Type of Pump Submersible high head drainage pump for construction and foundation works, floodwater drainage, etc.</p> <p>Type of Fluid Stormwater, groundwater, wash water, and sand-carrying water</p> <p>Temperature: 0 to 40°C</p> <p>Discharge Bore & Connection 100mm, JIS 10kg/cm² Screwed Flange</p> <p>Motor Output 30kW</p> <p>Power Supply Three-phase</p> <p>Starting Method Star-Delta</p> <p>Motor Continuous-duty rated, dry-type induction motor</p> <p>Insulation Class: F Degree of Protection: IP68</p> <p>No. of Poles & Speed (Synchronous Speed) 2-pole, 3000/3600min⁻¹ (50/60Hz)</p> <p>Power Supply Voltages & Rated Currents</p> <table border="0"> <tr> <td>50Hz</td> <td>60Hz</td> </tr> <tr> <td>380V – 58A</td> <td>220V – 99A</td> </tr> <tr> <td>400V – 55A</td> <td>380V – 57A</td> </tr> <tr> <td>415V – 55A</td> <td>440V – 50A</td> </tr> </table> <p>Power Cable Sheath: Chloroprene rubber Standard Length: 10m 200 to 600V supply: 1 x $\begin{pmatrix} 6 \times 22\text{mm}^2 \\ 1 \times 14\text{mm}^2 \\ 2 \times 2\text{mm}^2 \end{pmatrix}$ O.D. 38.8mm</p> <p>Dry Weight (excluding cable) 355kg</p>	50Hz	60Hz	380V – 58A	220V – 99A	400V – 55A	380V – 57A	415V – 55A	440V – 50A	<p>Impeller Closed Impeller made of high-chromium cast iron</p> <p>Solids Passage 50Hz – ϕ6mm 60Hz – ϕ6mm</p> <p>Mouth Ring Made of high-chromium cast iron, excellent in abrasion-resistance</p> <p>Cable Entry with Anti-Wicking Block Watertight cable entry with strain-relief device. The anti-wicking block prevents water incursion due to capillary action should the power cable be damaged or the end submerged.</p> <p>Bearing Permanently lubricated, deep-groove, double-shielded C3 ball bearings</p> <p>Shaft 420 stainless steel</p> <p>Shaft Seal (Mechanical Seal) Furnished with a double-face mechanical seal located in oil chamber. Both upper and lower seal faces always run in a clean environment.</p> <p>Upper Seal Face: SiC + SiC Lower Seal Face: SiC + SiC</p> <p>Pressure Relief Port Protects the mechanical seal from over rated limits, and also protects the seal faces from abrasive particles by drawing particles away.</p> <p>OIL LIFTER (Patented) Equipped in oil chamber. It forcibly supplies lubricating oil to the mechanical seal and continues to supply the oil to the upper seal faces even if lubricant falls below the rated volume.</p> <p>Type of Lubricating Oil & Volume Turbine Oil (ISO VG32), 6900ml</p> <p>Motor Protection Device A miniature thermal protector is embedded in each winding of the motor. Should excessive heat builds up, the bimetal strip opens to cause the control panel to shut the power supply.</p> <p>Galvanic Anode Protects the pump from electric corrosion, made of aluminium alloy</p>
50Hz	60Hz								
380V – 58A	220V – 99A								
400V – 55A	380V – 57A								
415V – 55A	440V – 50A								
TSURUMI MANUFACTURING CO., LTD.									

NO. A-11680-1

PUMP PERFORMANCE CURVES

TYPE SUBMERSIBLE GENERAL DEWATERING PUMP (HIGH HEAD)	MODEL LH430 -61	FREQUENCY 60 Hz
---	-----------------	-----------------

CUSTOMER'S NAME _____

EQUIPMENT TITLE _____

NO. _____

	STANDARD SPECIFICATIONS	REQUIRED SPECIFICATIONS
DISCHARGE BORE	100 mm	mm
TOTAL HEAD	75/50 m	m
CAPACITY	1.0/2.0 m ³ /min	m ³ /min
MOTOR OUTPUT	30 kW	kW
PHASE x VOLTAGE	3 ϕ x V	ϕ x V
CURRENT	A	A
POLES / REVOLUTION	2 P / S. S. 3600 min ⁻¹	P / min ⁻¹
STARTING METHOD	STAR-DELTA	
INSULATION CLASS	F	

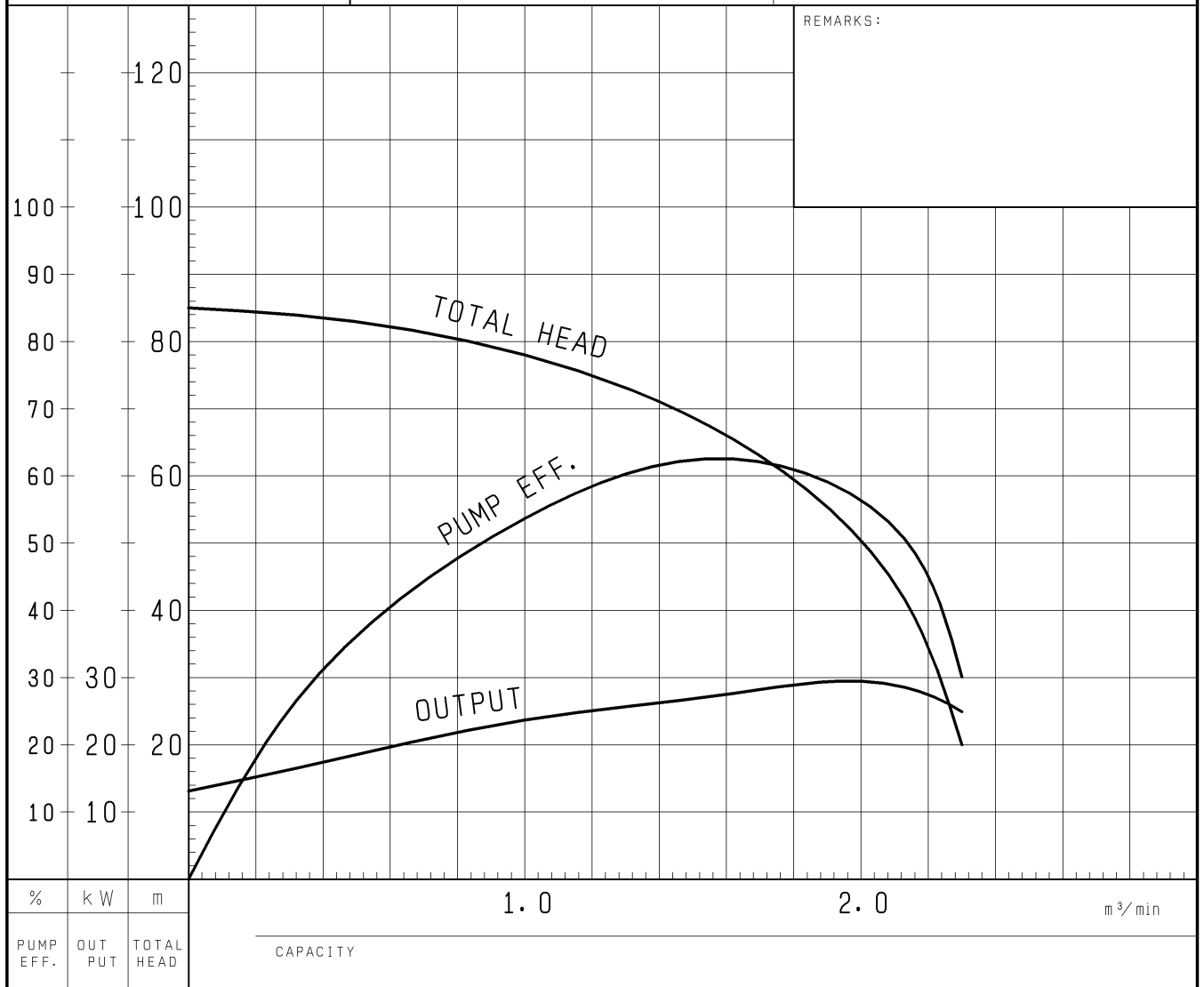

TSURUMI MFG. CO., LTD.

DIMENSION DRAWING		No.	No.	A-11685-2
TYPE	SUBMERSIBLE GENERAL DEWATERING PUMP (HIGH HEAD)	MODEL	LH422 -51/61 LH430 -51/61	

MODEL	Approximate Weight (※)
LH422-51/61	350kg
LH430-51/61	355kg

※excluding cable

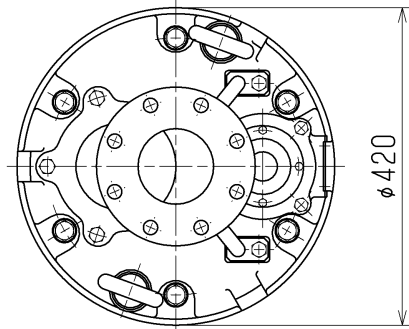

JIS10K Flange
Nominal Dia.
φ100

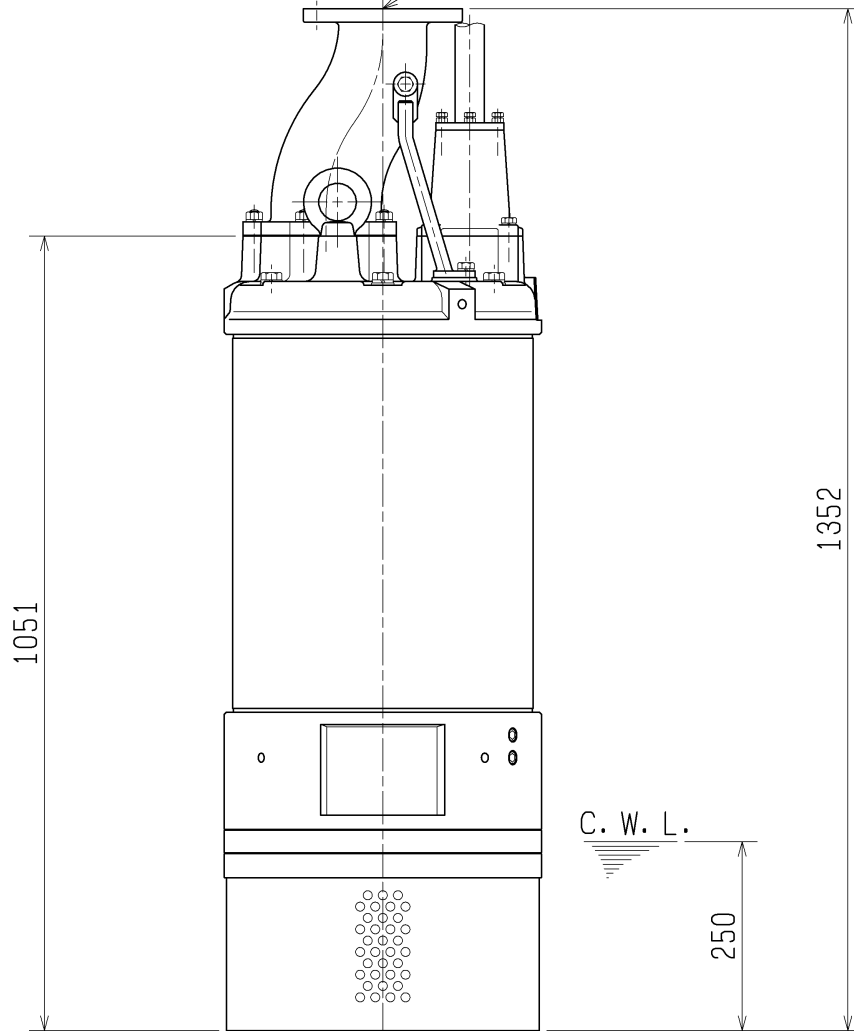

C. W. L. :Continuous running Water Level

SECTIONAL DRAWING		No.	No.	A-11690-4
TYPE	SUBMERSIBLE GENERAL DEWATERING PUMP (HIGH HEAD)	MODEL	LH430 -51/61	

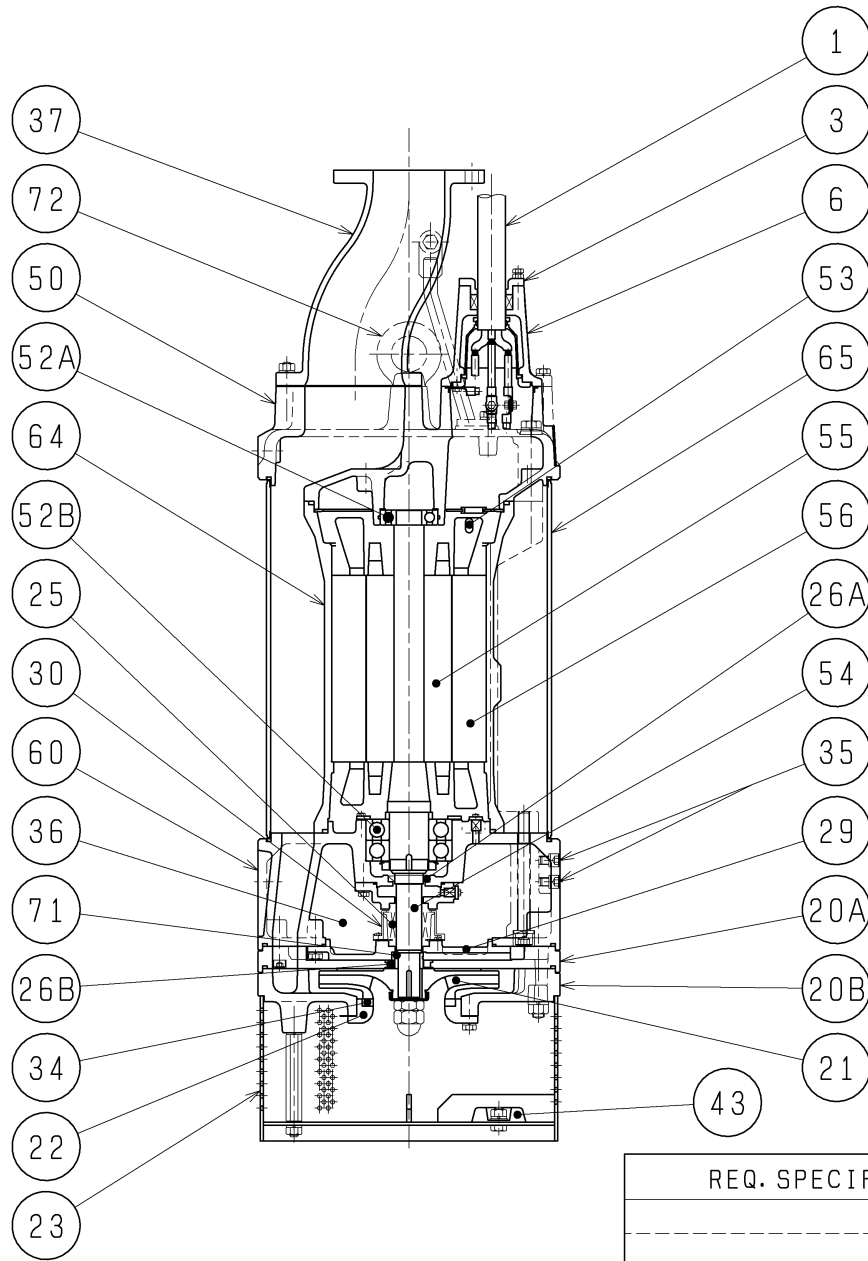

REQ. SPECIFICATION

No.	DESCRIPTION	Q'TY	MATERIAL / NOTE	No.	DESCRIPTION	Q'TY	MATERIAL / NOTE
1	Cabtyre Cable	1	Chloroprene Sheath	37	Discharge Pipe	1	Ductile Iron Casting
3	Gland	1	Gray Iron Casting	43	Cathodic Protection Plate	4	Aluminium
6	Stuffing Box	1	Gray Iron Casting	50	Motor Bracket	1	Gray Iron Casting
20A	Casing-upper Half	1	Ductile Iron Casting	52A	Upper Bearing	1	6307ZZC3
20B	Casing-lower Half	1	Ductile Iron Casting	52B	Lower Bearing	1	6311ZZD2C3
21	Impeller	1	Chromium Iron Casting	53	Motor Protector	3	
22	Suction Cover	1	Gray Iron Casting	54	Shaft	1	Stainless Steel 420J2
23	Strainer Stand	1	Structure Steel	55	Rotor	1	
25	Mechanical Seal	1	H-35T	56	Stator	1	
26A	Oil Seal	1	SC40588	60	Bearing Housing	1	Gray Iron Casting
26B	Labyrinth Ring	1	Stainless Steel 304	64	Motor Frame	1	Gray Iron Casting
29	Oil Casing	1	Gray Iron Casting	65	Outer Cover	1	Structure Steel
30	Oil Lifter	1	Plastic	71	Shaft Sleeve	1	Stainless Steel 403
34	Mouth Ring	1	Chromium Iron Casting	72	Eye Bolt	2	Stainless Steel 304
35	Oil Plug	2	Stainless Steel 304				
36	Lubricant		Turbine Oil (ISO VG32)				